



RFLM-202402QE/F-290

PIN Diode Limiter Module - SMT

Features:

- Surface Mount S - Band Limiter Module – 5mm x 8mm x 2.5mm
- Quasi Active High Power PIN Limiter Design
- Frequency Range: 2 to 4 GHz
- High Average Power Handling: 100W (CW)
- High Peak Power Handling: 1kW
- Low Insertion Loss: 0.5 dB
- Low Flat Leakage Power: 14 dBm
- Low Spike Energy Leakage: 0.5 ergs
- DC Blocking Capacitors per ‘E’ or ‘F’ Derivative
- “Always On Protection”
 - - No external control lines or power supply required
- RoHS Compliant

Description:

The RFLM-202402QE/F-290 SMT Silicon PIN Diode Limiter Modules offers “Always On” High Power CW and Peak protection in the S-Band region. This family of Limiter Modules are based on proven hybrid assembly technique utilized extensively in high reliability, mission critical applications. The RFLM-202402QE/F-290 offers excellent thermal characteristics in a compact, low profile 8mm x 5mm x 2.5mm package. They designed for optimal small signal insertion loss permitting extremely low receiver noise figure while simultaneously offering excellent large input signal Flat Leakage for effective receiver protection in the S Band frequency range.

The RFLM-202402QE/F-290 Limiter Modules provide outstanding passive receiver protection (Always on) which protects against High Average Power up to 100W, High Peak Power up to 1kW pulsed, maintains low flat leakage to less than 14 dBm (typ), and reduces Spike Leakage to less than 0.5 ergs (typ).

ESD and Moisture Sensitivity Rating

The RFLM-202402QE/F-290 Limiter Module carries a Class 0 ESD rating (HBM) and an MSL 1 moisture rating.

Thermal Management Features

The proprietary design methodology minimizes the thermal resistance from the PIN Diode junction to base plate (RTHJ-A) to less than 40°C/W. The two stage limiter design employs a two stage detector circuit which enables ultra-fast turn on of the High Power PIN Diodes. This circuit topology coupled with the thermal characteristic of

the substrate design enables the Limiter Module to reliably handling High Input RF Power up to 50 dBm CW and RF Peak Power levels up to 60 dBm (25 uSec pulse width @ 5.0% duty cycle) with base plate temperature at 85°C. The RFLM-202402QE/F-290 based substrate has been design to offer superior long term reliability in the customer’s application by utilizing ultra-thin Au plating to combat Au embrittlement concerns.

RFLM-202402QE-290: Limiter Module Schematic - with Input RF Blocking Capacitor Only

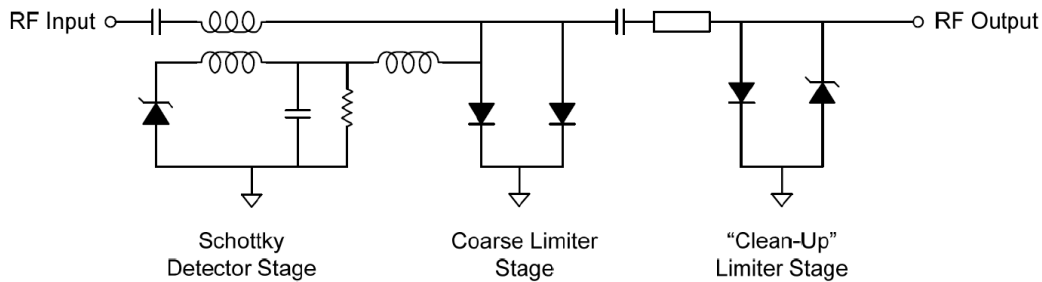

RFLM-202402QE/F-290: Limiter Module Schematic - with Input & Output RF Blocking Capacitors

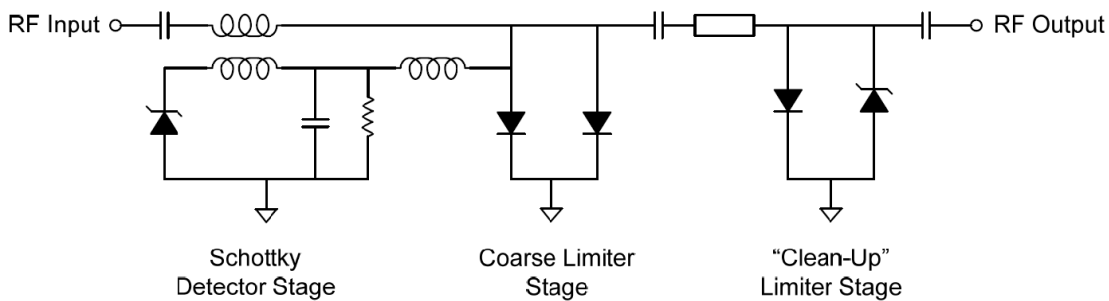

Absolute Maximum Ratings

@ $Z_o=50\Omega$, $T_A=+25^\circ\text{C}$ as measured on the base ground surface of the device.

Parameter	Conditions	Absolute Maximum Value
Operating Temperature		-65°C to 125°C
Storage Temperature		-65°C to 150°C
Junction Temperature		175°C
Assembly Temperature	T = 30 seconds	260°C
RF Peak Incident Power	$T_{CASE}=85^\circ\text{C}$, source and load VSWR < 1.2:1, RF Pulse width = 25 usec, duty cycle = 5%, derated linearly to 0 W at $T_{CASE}=150^\circ\text{C}$ (note 1)	60 dBm
RF CW Incident Power	$T_{CASE}=85^\circ\text{C}$, source and load	50 dBm

	VSWR < 1.2:1, derated linearly to 0 W at T _{CASE} =150°C (note 1)	
θ _{JC} Thermal Resistance	From PIN Diode Junction to bottom surface of package	40°C/W
RF Input & Output DC Block Capacitor Voltage Breakdown		100 V DC

Note 1: T_{CASE} is defined as the temperature of the bottom ground surface of the device.

RFLM202402QE/F-290 Electrical Specifications

@ Z₀=50Ω, TA= +25°C as measured on the base ground surface of the device.

Parameters	Symbol	Test Conditions	Min Value	Typ Value	Max Value	Units
Frequency	F	2 GHz ≤ F ≤ 4 GHz	2		4	GHz
Insertion Loss	IL	2 GHz ≤ F ≤ 4 GHz, P _{in} = -10 dBm		0.5	0.7	dB
Insertion Loss Rate of Change vs Operating Temperature	ΔIL	2 GHz ≤ F ≤ 4 GHz, P _{in} ≤ -10 dBm		0.005		dB/°C
Return Loss	RL	2 GHz ≤ F ≤ 4 GHz, P _{in} = -10 dBm	12	14		dB
Input 1 dB Compression Point	IP _{1dB}	2 GHz ≤ F ≤ 4 GHz	0	8	11	dBm
2 nd Harmonic	2F _o	P _{in} = -10 dBm, F _o = 3.0 GHz		-40	-30	dBc
Peak Incident Power	P _{inc(PK)}	RF Pulse = 25 usec, duty cycle = 5%, t _{rise} ≤ 3us, t _{fall} ≤ 3 usec			60	dBm
CW Incident Power	P _{inc(CW)}	2 GHz ≤ F ≤ 4 GHz			50	dBm
Flat Leakage	FL	P _{in} = 60 dBm, RF Pulse width = 25 us, duty cycle = 5%, t _{rise} ≤ 3 us, t _{fall} ≤ 3 us		14	15	dBm
Spike Leakage	SL	P _{in} = 60 dBm, RF Pulse width = 25 us, duty cycle = 5%		0.5	0.7	erg
Recovery Time	T _R	50% falling edge of RF Pulse to 1 dB IL, P _{in} = 60 dBm peak, RF PW = 25 us, duty cycle = 5%, trise ≤ 3us, t _{fall} ≤ 3 usec		3	5	usec

RFLM-202402QE/F-290 Typical Performance

$Z_0 = 50\Omega$, $T_{CASE} = 25^\circ\text{C}$, PIN = 0 dBm as measured on the Ground Plane of the device.

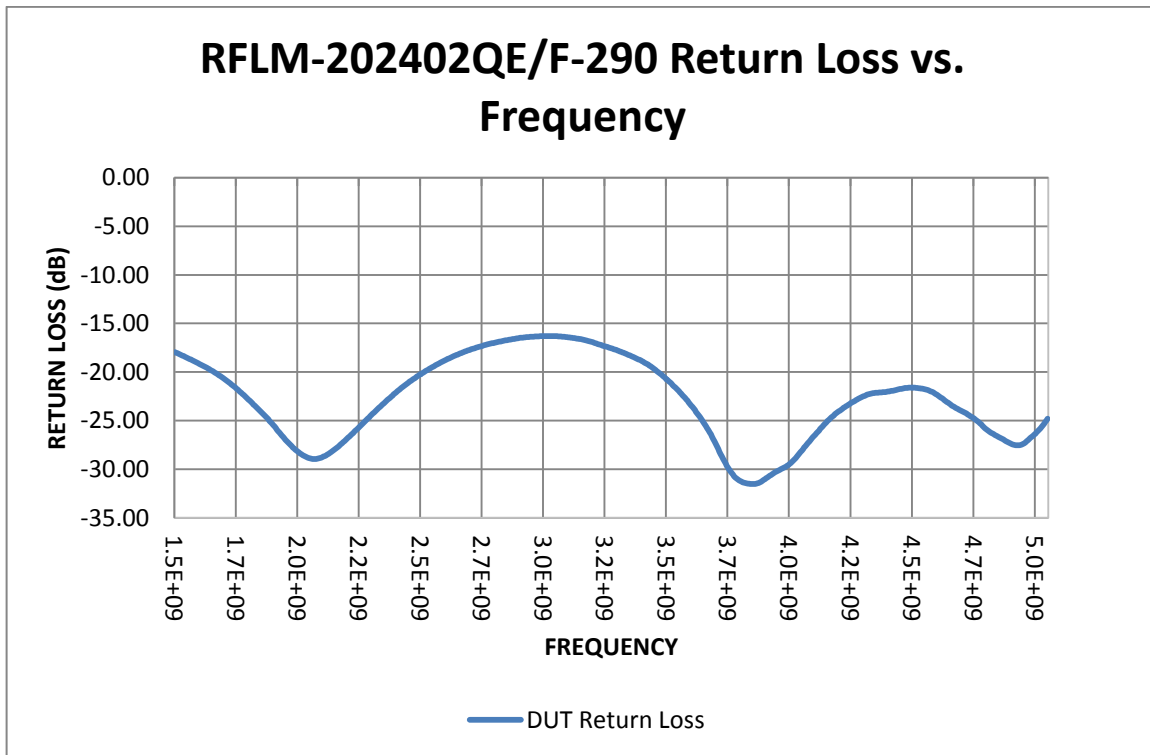
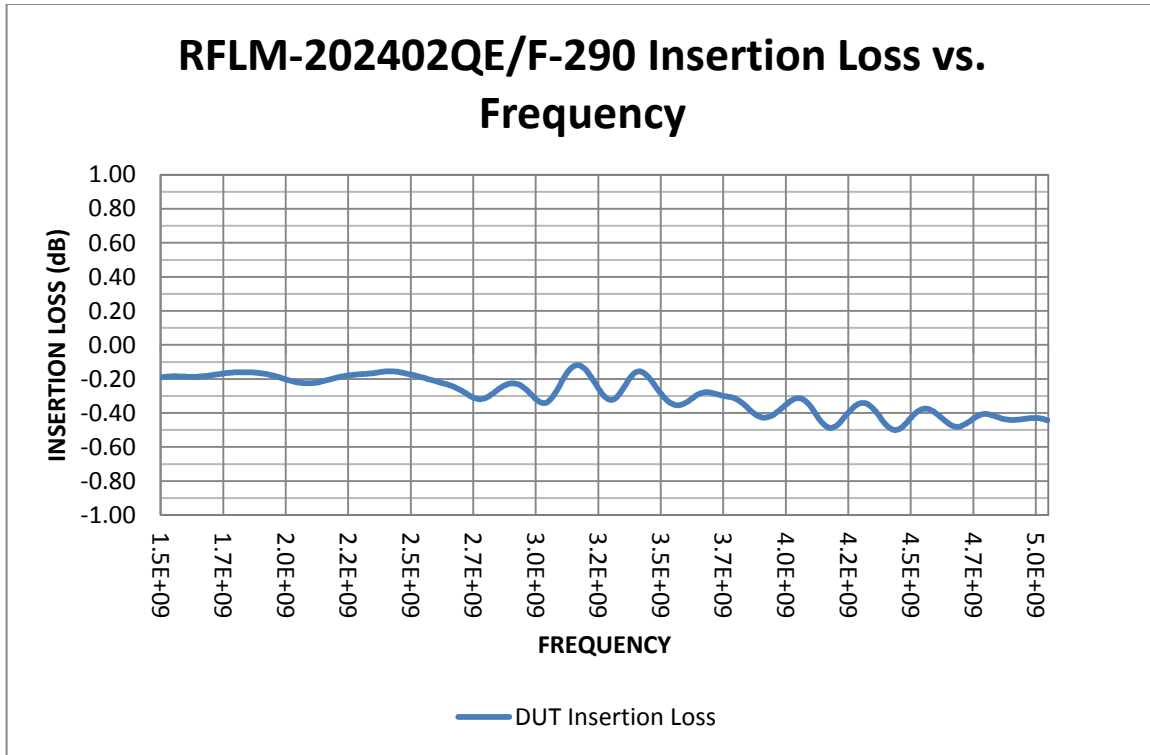

RFLM-102402QE/F-290: Pin vs Pout

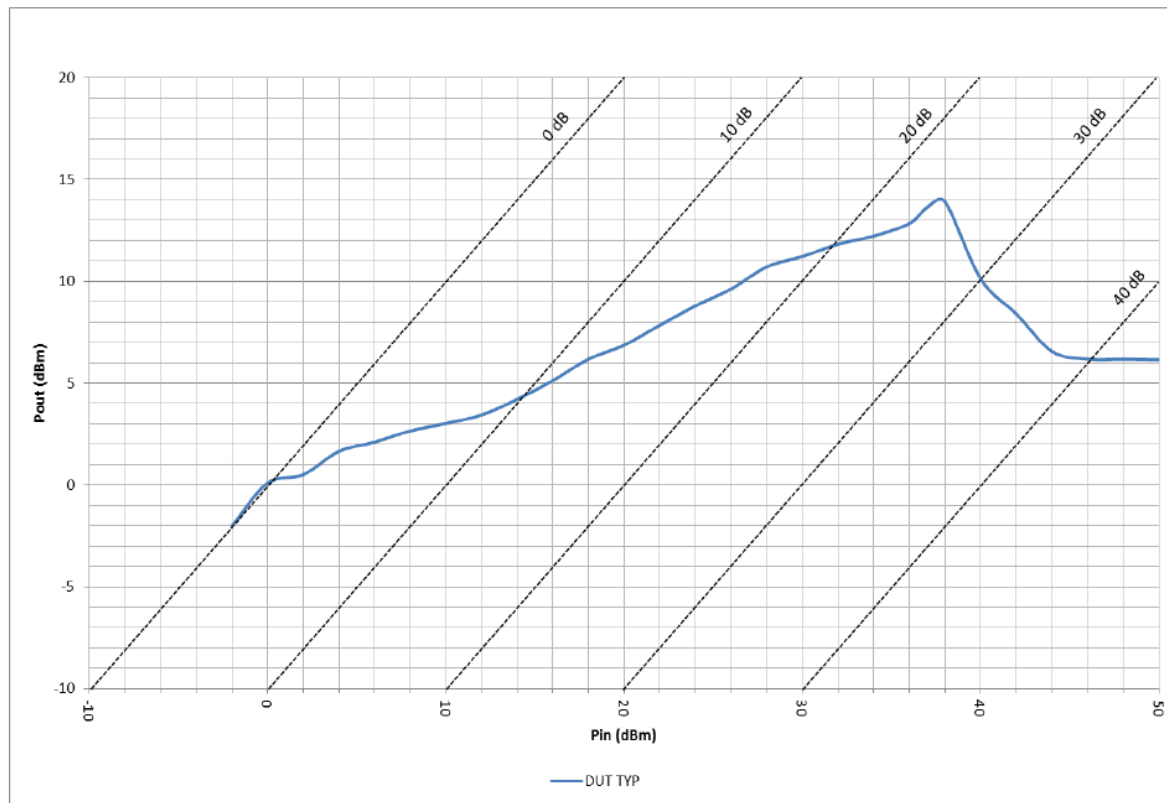

Assembly Instructions

The RFLM-202402QE/F-290 may be attached to the printed circuit card using solder reflow procedures using either RoHS or Sn63/ Pb37 type solders per the Table and Temperature Profile Graph shown below:

Profile Parameter	Sn-Pb Assembly Technique	RoHS Assembly Technique
Average ramp-up rate (T_L to T_P)	3°C/sec (max)	3°C/sec (max)
Preheat		
Temp Min (T_{smin})	100°C	100°C
Temp Max (T_{smax})	150°C	150°C
Time (min to max) (t_s)	60 – 120 sec	60 – 180 sec
T_{smax} to T_L		
Ramp up Rate		3°C/sec (max)
Peak Temp (T_P)	225°C +0°C / -5°C	260°C +0°C / -5°C
Time within 5°C of Actual Peak Temp (T_P)	10 to 30 sec	20 to 40 sec
Time Maintained Above:		
Temp (T_L)	183°C	217°C
Time (t_L)	60 to 150 sec	60 to 150 sec
Ramp Down Rate	6°C/sec (max)	6°C/sec (max)
Time 25°C to T_P	6 minutes (max)	8 minutes (max)

Solder Re-Flow Time-Temperature Profile

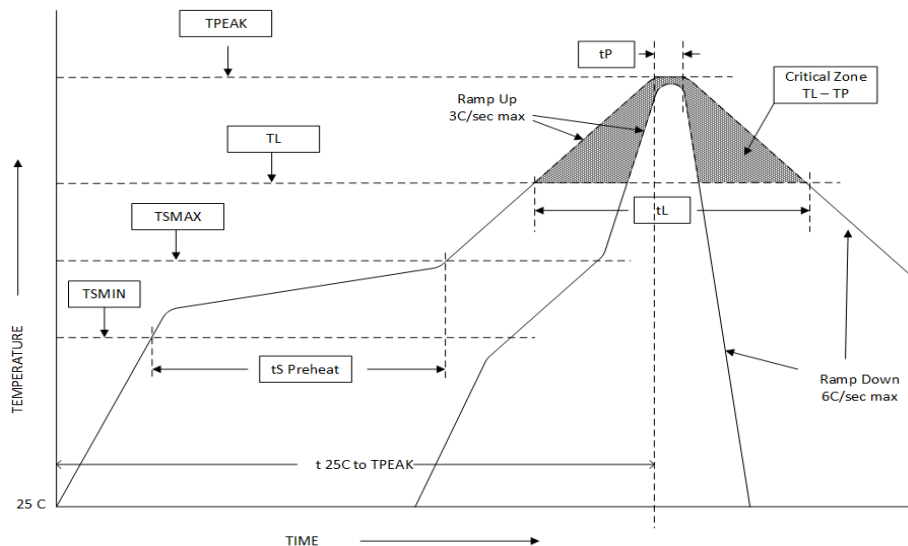

RFLM-202402QE/F-290 Limiter Module Package Outline Drawing

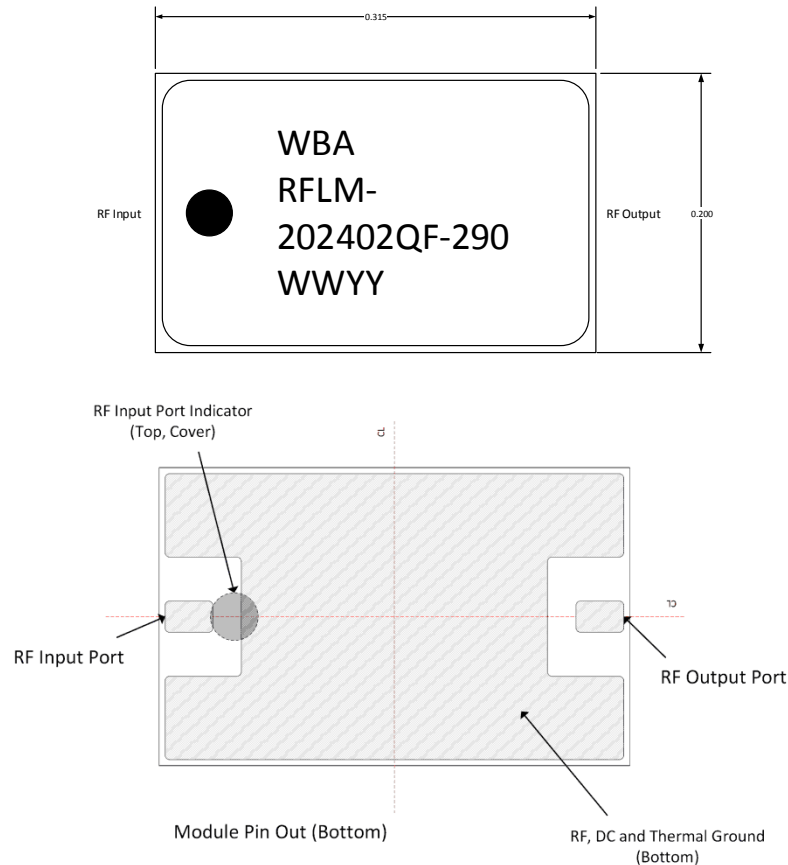

Notes:

- 1) Metalized area on backside is the RF, DC and Thermal ground. In user's end application this surface temperature must be managed to meet the power handling requirements.
- 2) Back side metallization is thin Au termination plating to combat Au embrittlement (Au plated over Cu).
- 3) Unit = mils

Thermal Design Considerations:

The design of the RFLM-202402QE/F-290 Limiter Module permits the maximum efficiency in thermal management of the PIN Diodes while maintaining extremely high reliability. Optimum Limiter performance and reliability of the device can be achieved by the maintaining the base ground surface temperature of less than 85°C.

There must be a minimal thermal and electrical resistance between the limiter module and ground. Adequate thermal management is required to maintain a T_{jc} at less than +175°C and thereby avoid adversely affecting the semiconductor reliability. Special care must be taken to assure that minimal voiding occurs in the solder connection in the areas shade in red in the figure shown below.

Module RF and Thermal Consideration

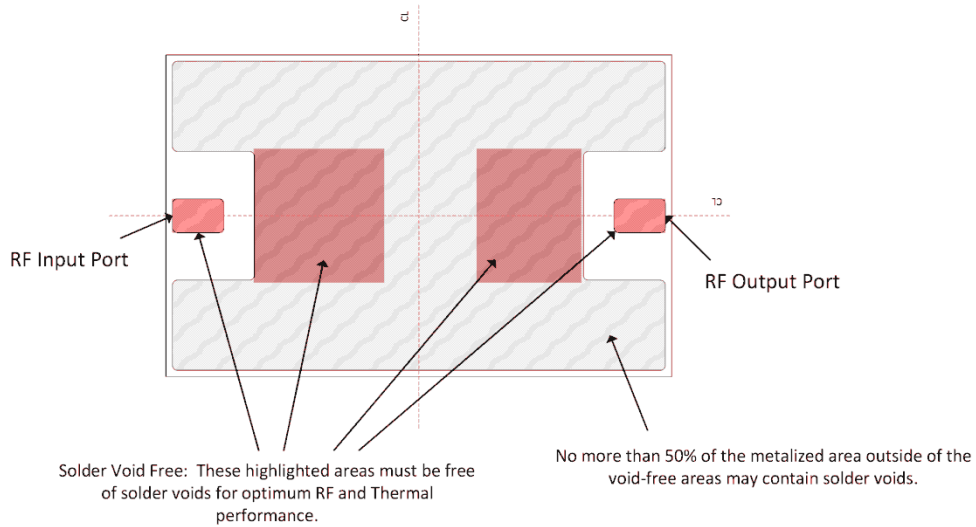

Recommended RF Circuit Solder Footprint for the RFLM-202402QE/F-290

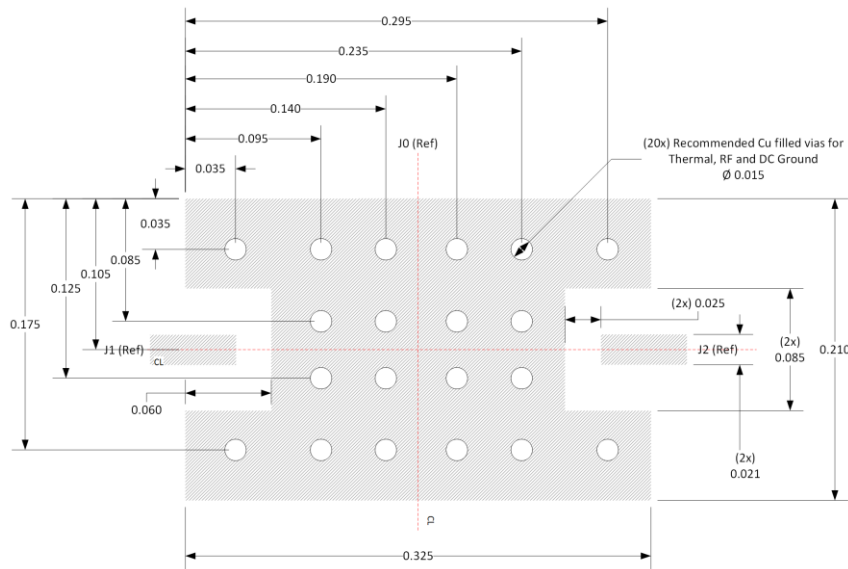

Notes:

- 1) Recommended PCB material is Rogers 4350B, 10 mils thick (RF Input and Output trace width needs to be adjusted from the recommended footprint.)
- 2) Hatched area is RF, DC and Thermal Ground. Vias should be solid Cu filled and Au plated for optimal heat transfer from backside of Limiter Module through circuit vias to thermal ground.
- 3) Unit = mils

Part Number Ordering Detail:

The RFLM-202402QE/F-290 Limiter Module is available in either tube or Tape & Reel format.

Part Number	Description	Packaging
RFLM-202402QF-290	S-Band Limiter with Input & Output DC Blocking Caps	Tube
RFLM-202402QF-290TR	S-Band Limiter with Input & Output DC Blocking Caps	TR (250 pcs)
RFLM-202402QE-290	S-Band Limiter with Input DC Blocking Caps	Tube
RFLM-202402QE-290TR	S-Band Limiter with Input DC Blocking Caps	TR (250 pcs)