



RFLM-102402QE/F-290

Wei Bo Associates HK Limited

PIN Diode L & S Band Limiter Module - SMT

Features:

- Surface Mount L & S - Band Limiter Module – 5mm x 8mm x 2.5mm
- Quasi Active High Power PIN Limiter Design
- Frequency Range: 1 to 4 GHz
- High Average Power Handling: 100W (CW)
- High Peak Power Handling: 1kW
- Low Spike Energy Leakage: 0.5 ergs
- Low Insertion Loss: 0.5 dB
- Extremely Low Flat Leakage Power: 14 dBm
- Input & Output DC Coupling Capacitors
- No external control lines or power supply required
- RoHS Compliant

Description:

The RFLM-102402QE/F-290 SMT Silicon PIN Diode Limiter Module offer both High Power CW and Peak protection across the L & S-Band region. It is based on proven hybrid assembly technique utilized extensively in high reliability, mission critical applications. The RFLM-102402QE/F-290 offers excellent thermal characteristics in a compact, low profile 8mm x 5mm x 2.5mm package. The RFLM-102402QE/F-290 is designed for optimal small signal insertion loss permitting extremely low receiver noise figure while simultaneously offering excellent large input signal Flat Leakage for effective receiver protection in the S Band frequency range.

The RFLM-102402QE/F-290 Limiter Module provides outstanding passive receiver protection (always on) which protects against High Average Power up to 100W (CW), High Peak Power up to 1kW pulsed, maintains low flat leakage to less than 14 dBm (typ) and reduces Spike Leakage to less than 0.5 ergs.

ESD and Moisture Sensitivity Rating

The RFLM-102402QE/F-290 Limiter Module carries a Class 0 ESD rating (HBM) and an MSL 1 moisture rating.

Thermal Management Features

The RFLM-102402QE/F-290 based substrate has been design to offer superior long term reliability in the customer's application by utilizing ultra-thin Au plating to combat Au embrittlement concerns. Also, a proprietary design methodology has minimized the thermal resistance from the PIN Diode junction to base plate (R_{THJ-A}) to 40°C/W. The two stage limiter design employs a second stage Schottky and quarter wavelength spacer

detector circuit which permits ultra-fast turn on of the High Power PIN Diodes. This circuit topology couple with the thermal characteristic of the substrate design enables reliably handling High Input RF Power up to 50 dBm CW and RF Peak Power levels up to 60 dBm (25 uSec pulse width @ 1.0% duty cycle with base plate temperature at 85°C). The I layer of the PIN diodes have been selected to produce a flat leakage of 15 dBm typical and a spike leakage of 0.5 ergs typical.

RFLM-102402QE/F-290 Limiter Module Schematic - with Input & Output RF Coupling Capacitors

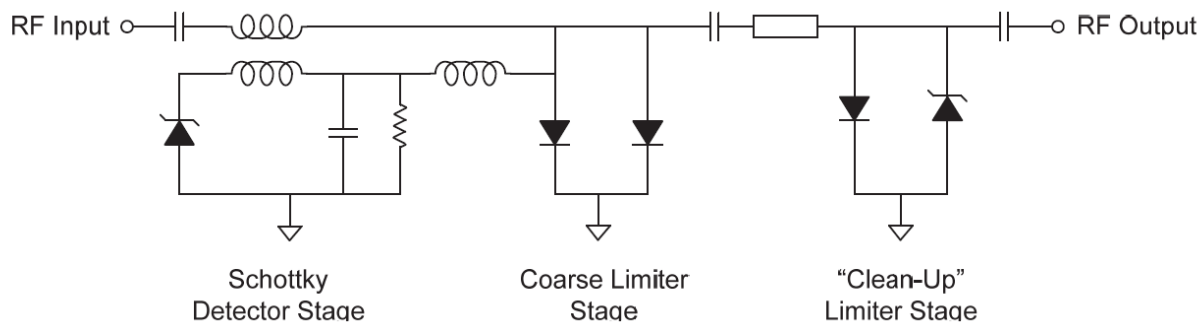

Absolute Maximum Ratings

@ $Z_0=50\Omega$, $T_A=+25^\circ\text{C}$ as measured on the base ground surface of the device.

Parameter	Conditions	Absolute Maximum Value
Operating Temperature		-65°C to 125°C
Storage Temperature		-65°C to 150°C
Junction Temperature		175°C
Assembly Temperature	T = 30 seconds	260°C
RF Peak Incident Power	$T_{\text{CASE}}=85^\circ\text{C}$, source and load VSWR < 1.2:1, RF Pulse width = 25 usec, duty cycle = 5%, derated linearly to 0 W at $T_{\text{CASE}}=150^\circ\text{C}$ (See note 1)	60 dBm
RF CW Incident Power	$T_{\text{CASE}}=85^\circ\text{C}$, source and load VSWR < 1.2:1, derated linearly to 0 W at $T_{\text{CASE}}=150^\circ\text{C}$ (See note 1)	50 dBm
θ_{JC} Thermal Resistance		40°C/W
RF Input & Output DC Block Capacitor Voltage Breakdown		100 V DC

Note 1: T_{CASE} is defined as the temperature of the bottom ground surface of the device.

RFLM102402QE/F-290 Electrical Specifications

@ Zo=50Ω, TA= +25°C as measured on the base ground surface of the device.

Parameters	Symbol	Test Conditions	Min Value	Typ Value	Max Value	Units
Frequency	F	1 GHz ≤ F ≤ 4 GHz	1.0		4.0	GHz
Insertion Loss	IL	1 GHz ≤ F ≤ 4 GHz, P _{in} = 0 dBm		0.35	0.45	dB
Insertion Loss Rate of Change vs Operating Temperature	ΔIL	1 GHz ≤ F ≤ 4 GHz, P _{in} ≤ -10 dBm		0.005		dB/°C
Return Loss	RL	1 GHz ≤ F ≤ 4 GHz, P _{in} = 0 dBm	16	>17		dB
Input 1 dB Compression Point	IP _{1dB}	1 GHz ≤ F ≤ 4 GHz	0	8	11	dBm
2 nd Harmonic	2F _o	P _{in} = -10 dBm, F _o = 3.0 GHz		-40	-30	dBc
Peak Incident Power	P _{inc(PK)}	RF Pulse = 25 usec, duty cycle = 5%, t _{rise} ≤ 2us, t _{fall} ≤ 2 usec			60	dBm
CW Incident Power	P _{inc(CW)}	2 GHz ≤ F ≤ 4 GHz			50	dBm
Flat Leakage	FL	P _{in} = 60 dBm, RF Pulse width = 25 us, duty cycle = 5%, t _{rise} ≤ 2 us, t _{fall} ≤ 2 us		14	15	dBm
Spike Leakage	SL	P _{in} = 60 dBm, RF Pulse width = 25 us, duty cycle = 5%		0.5	0.7	erg
Recovery Time	T _R	50% falling edge of RF Pulse to 1 dB IL, P _{in} = 50 dBm peak, RF PW = 25 us, duty cycle = 5%, trise ≤ 2us, t _{fall} ≤ 1 usec		3	5	usec

RFLM-102402QE/F-290 Typical Performance

$Z_0 = 50\Omega$, $T_{CASE} = 25^\circ\text{C}$, PIN = 0 dBm as measured on the Ground Plane of the device.

RFLM-102402QE/F-290: Insertion Loss vs Frequency

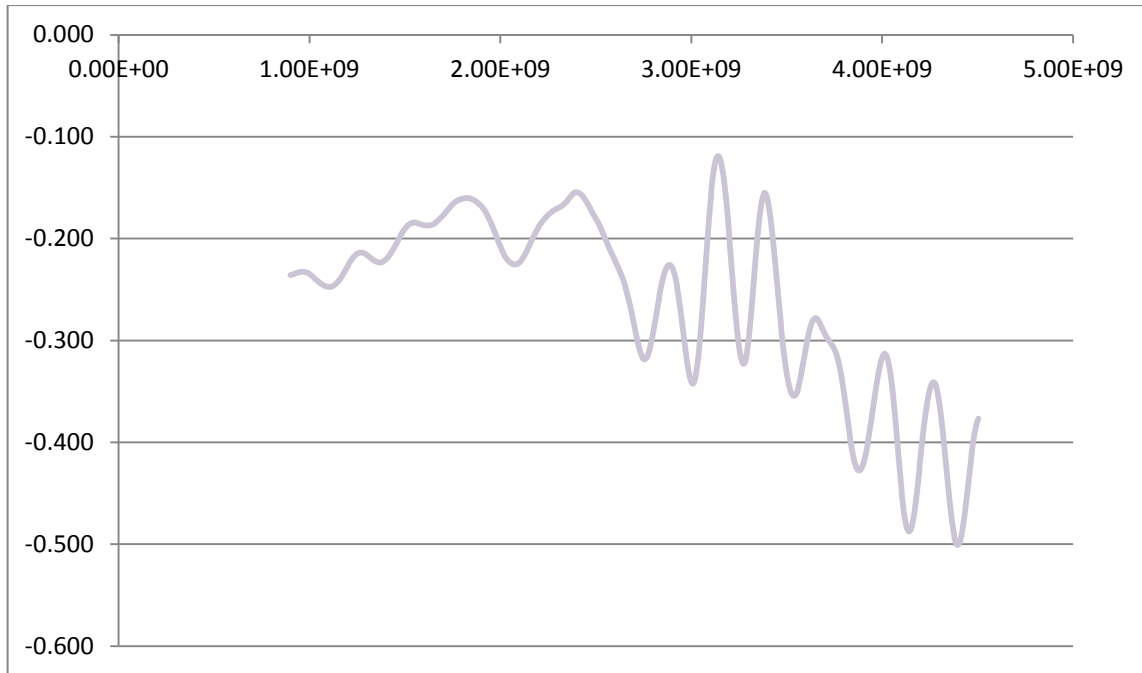

RFLM-102402QE/F-290: Return Loss vs Frequency

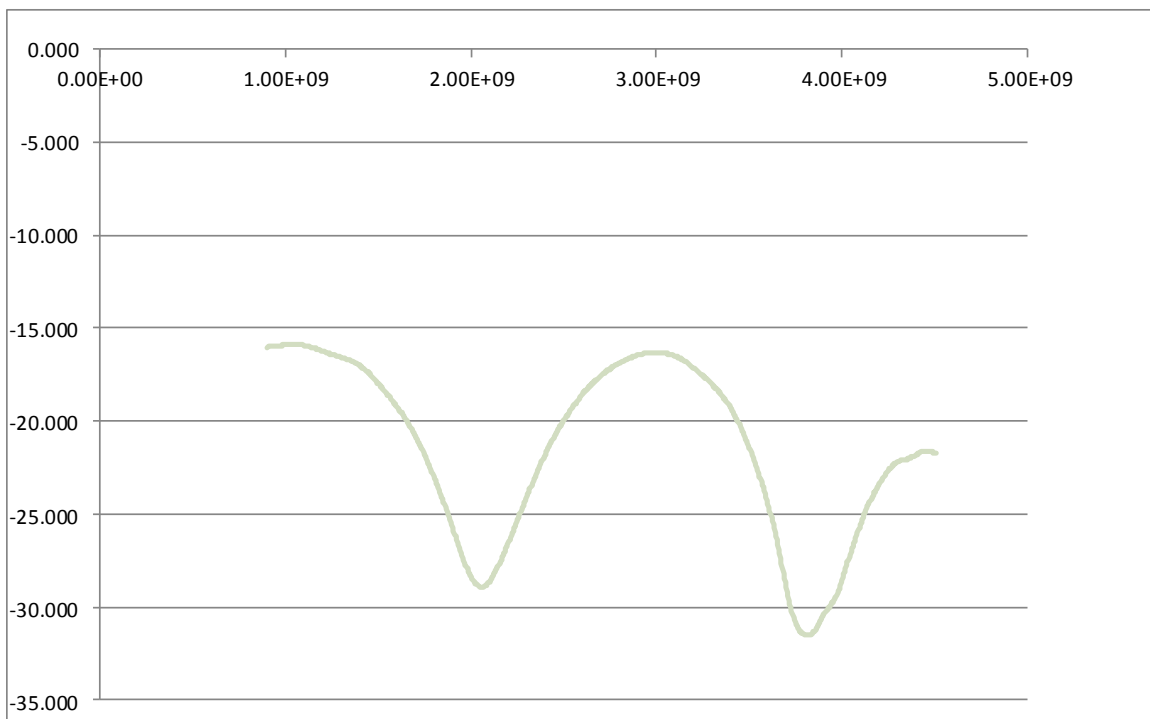

RFLM-102402QE/F-290: Pin vs Pout

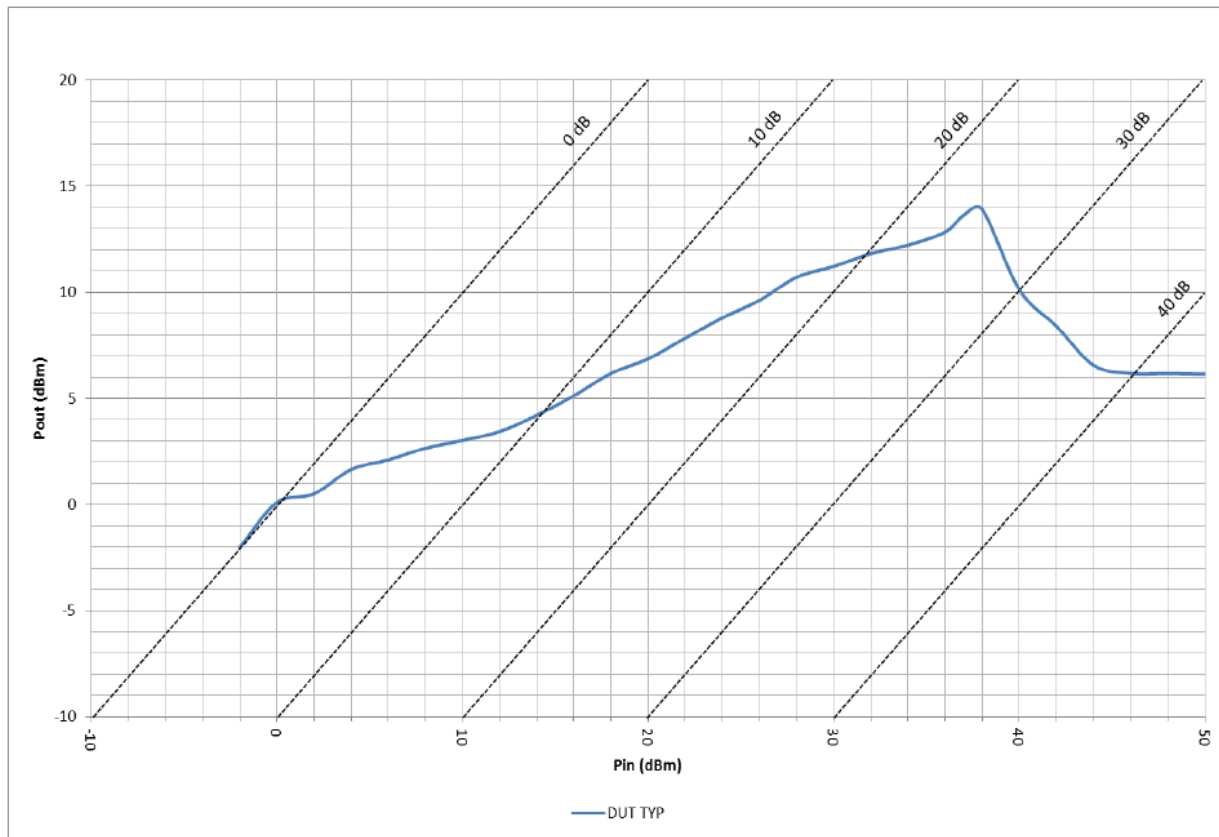

Assembly Instructions

The RFLM-102402QF-290 may be attached to the printed circuit card using solder reflow procedures using either RoHS or Sn63/ Pb37 type solders per the Table and Temperature Profile Graph shown below:

Profile Parameter	Sn-Pb Assembly Technique	RoHS Assembly Technique
Average ramp-up rate (T_L to T_P)	3°C/sec (max)	3°C/sec (max)
Preheat		
Temp Min (T_{smin})	100°C	100°C
Temp Max (T_{smax})	150°C	150°C
Time (min to max) (t_s)	60 – 120 sec	60 – 120 sec
T_{smax} to T_L		
Ramp up Rate		3°C/sec (max)
Peak Temp (T_P)	225°C +0°C / -5°C	260°C +0°C / -5°C
Time within 5°C of Actual Peak Temp (T_P)	10 to 30 sec	20 to 40 sec
Time Maintained Above:		
Temp (T_L)	183°C	217°C
Time (t_L)	60 to 150 sec	60 to 150 sec
Ramp Down Rate	6°C/sec (max)	6°C/sec (max)
Time 25°C to T_P	6 minutes (max)	8 minutes (max)

Solder Re-Flow Time-Temperature Profile

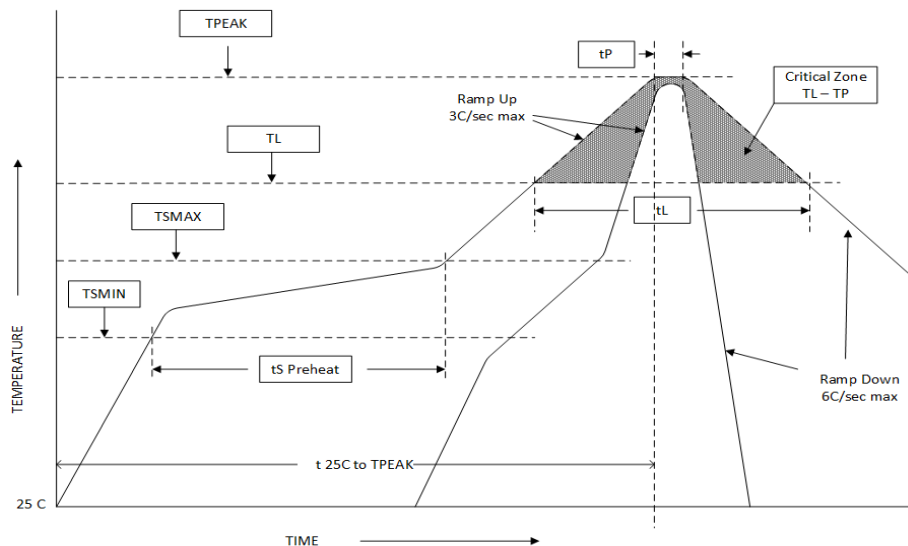

RFLM-102402QE/F-290 Limiter Module Package Outline Drawing

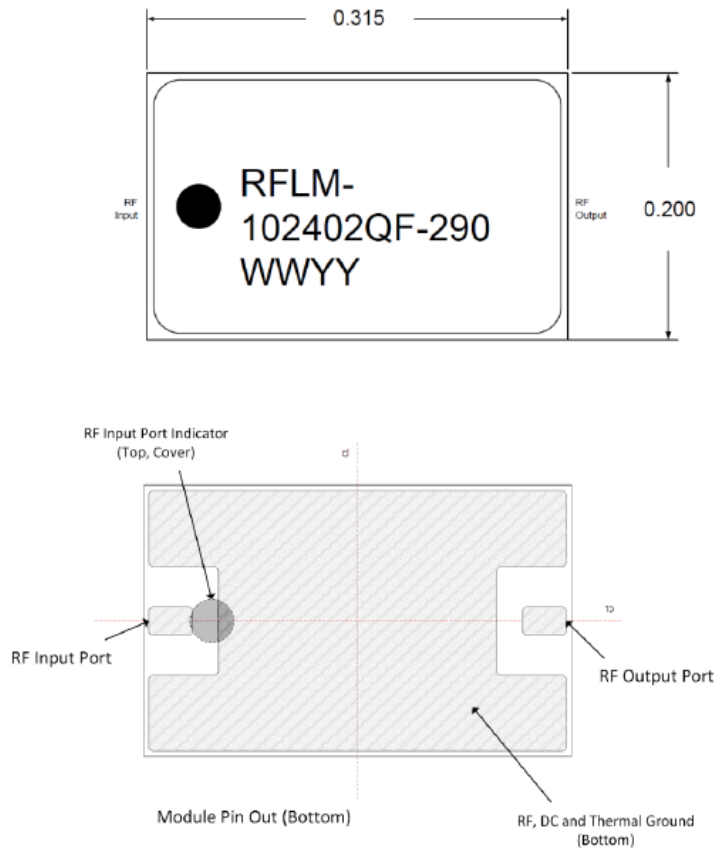

Notes:

- 1) Metalized area on backside is the RF, DC and Thermal ground. In user's end application this surface temperature must be managed to meet the power handling requirements.
- 2) Back side metallization is thin Au termination plating to combat Au embrittlement (Au plated over Cu).
- 3) Unit = mils

Thermal Design Considerations:

The design of the RFLM-102402QF-290 Limiter Module permits the maximum efficiency in thermal management of the PIN Diodes while maintaining extremely high reliability. Optimum Limiter performance and reliability of the device can be achieved by the maintaining the base ground surface temperature of less than 85°C.

There must be a minimal thermal and electrical resistance between the limiter module and ground. Adequate thermal management is required to maintain a T_{jc} at less than +175°C and thereby avoid adversely affecting

the semiconductor reliability. Special care must be taken to assure that minimal voiding occurs in the solder connection in the areas shade in red in the figure shown below.

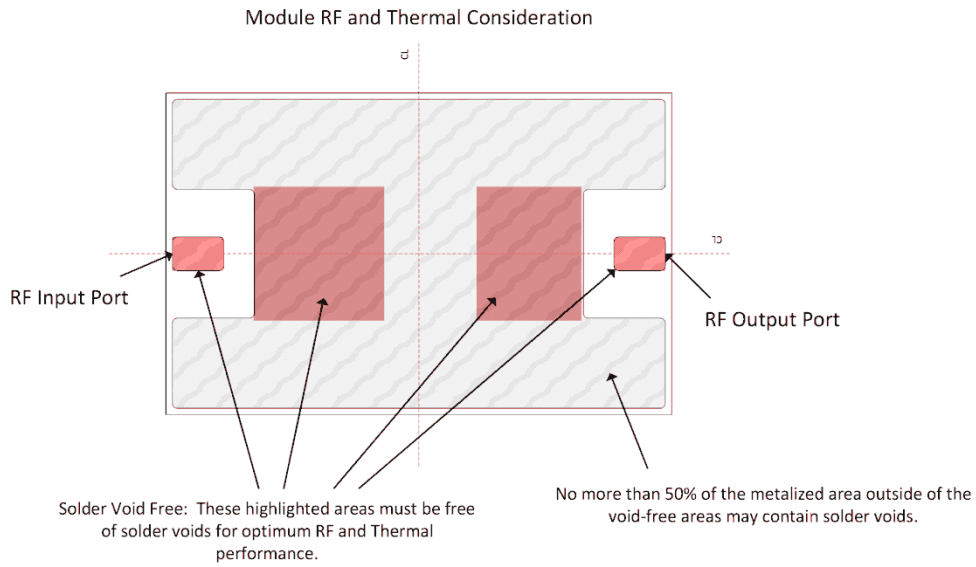

Recommended RF Circuit Solder Footprint for the RFLM-102402QE/F-290

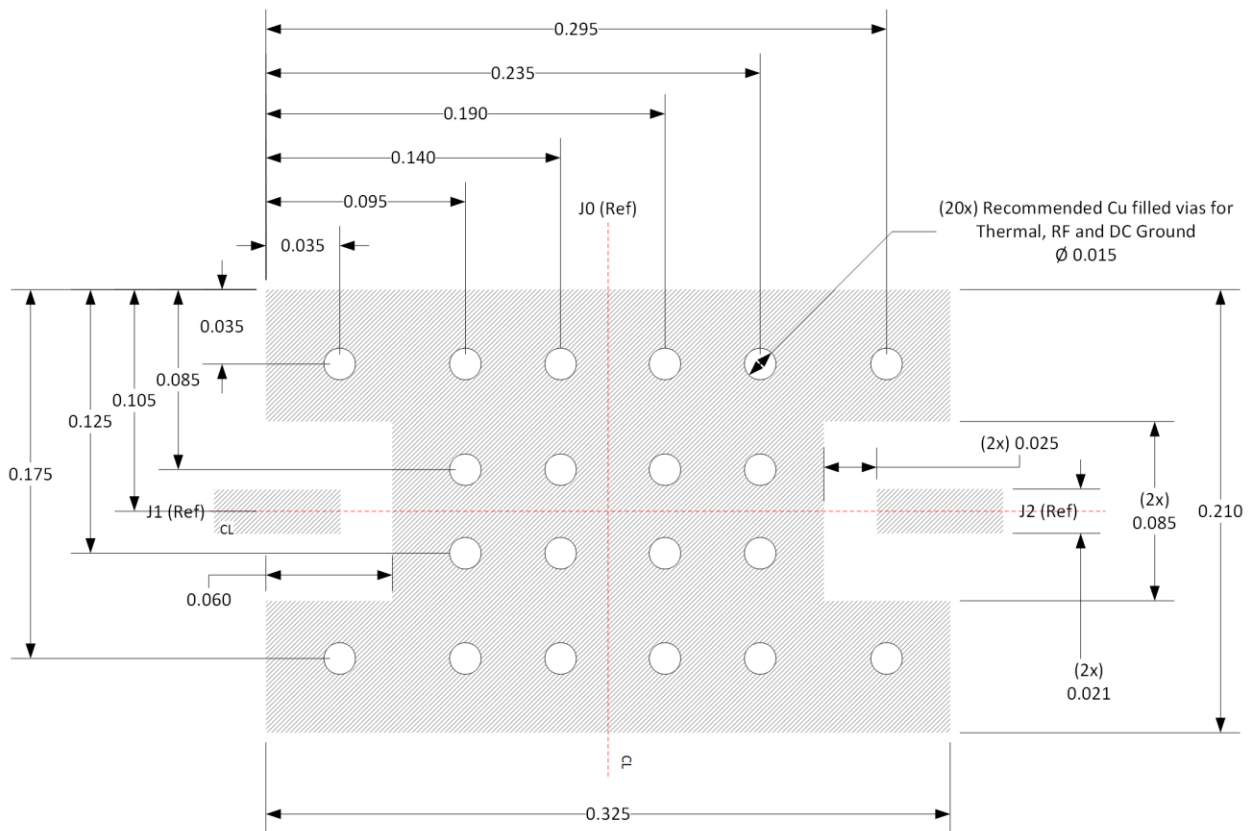

Notes:

- 1) Recommended PCB material is Rogers 4350B, 10 mils thick (RF Input and Output trace width needs to be adjusted from the recommended footprint.)
- 2) Hatched area is RF, DC and Thermal Ground. Vias should be solid Cu filled and Au plated for optimal heat transfer from backside of Limiter Module through circuit vias to thermal ground.
- 3) Unit = mils

Part Number Ordering Detail:

The RFLM-102402QF-290 Limiter Module is available in either tube or Tape & Reel format.

Part Number	Description	Packaging
RFLM-102402QE-290	L & S-Band Limiter, with Input DC Blocking Caps	Tube
RFLM-102402QE-290TR	L & S-Band Limiter, with Input DC Blocking Caps	TR (250 pcs)
RFLM-102402QF-290	L & S-Band Limiter, with DC Blocking Caps	Tube
RFLM-102402QF-290TR	L & S-Band Limiter, with DC Blocking Caps	TR (250 pcs)